

SAM-HAN 육각 개비온 상세도

(1.0 x 1.0 x 0.5^M)

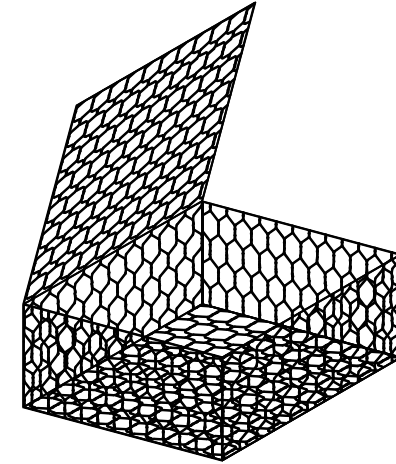
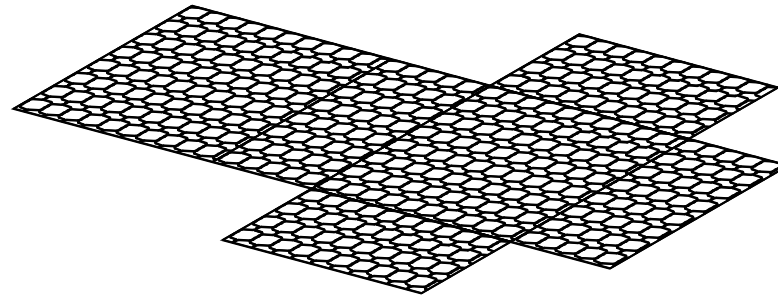
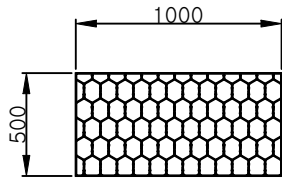

전 개 도

조립도

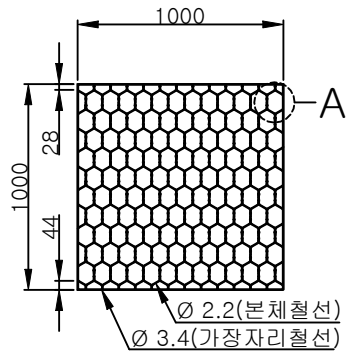

상세도 - A

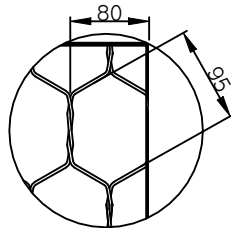

MATERIAL TABLE

DESCRIPTION	SIZE	Q'TY	REMARK
SHEET	Ø2.2 mm 3,000 x 1,000	1EA	SELVEDGE WIRE 3.4mm
SHEET	Ø2.2 mm 1,000 x 500	2EA	SELVEDGE WIRE 3.4mm
결속선	Ø2.2 mm		

(주) 삼 한

본사공장
TEL : 061)372-8887
FAX : 061)372-8150

도면명
SHG-B1005